

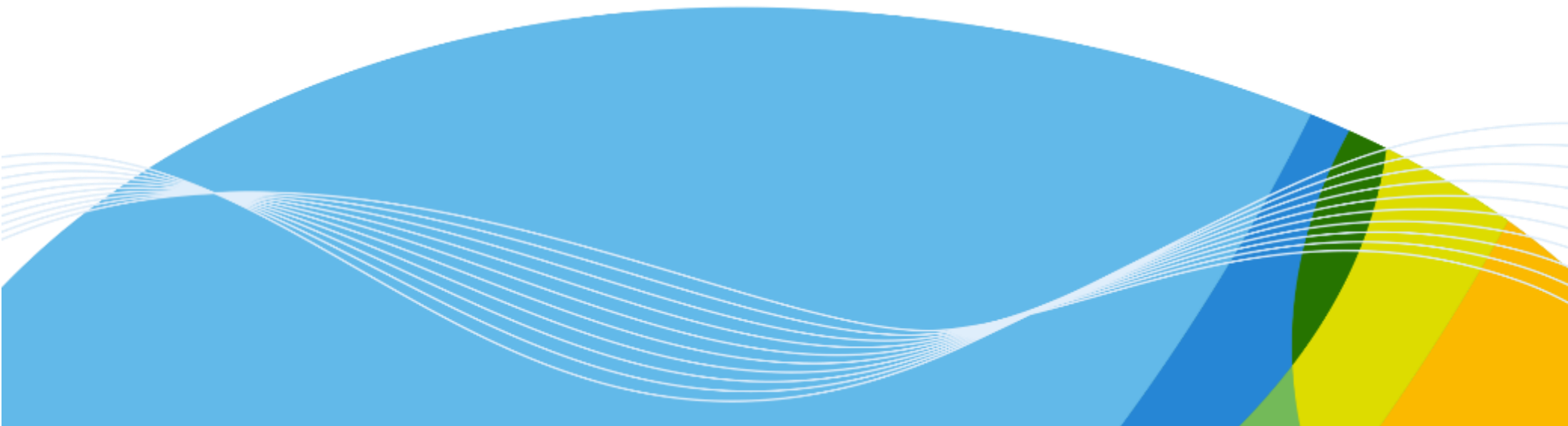

# SmartMet Server

## Providing MetOcean Data

**Roope Tervo, Mika Heiskanen, Mikko Rauhala, Tarja Riihisaari**  
Finnish Meteorological Institute







# FMI Open Data

Finnish Meteorological Institute opened its data in 2013.

Basically everything that FMI has property rights was opened.

Data is provided in freely in machine readable format.

## FMI DATA

<https://en.ilmatieteenlaitos.fi/open-data>

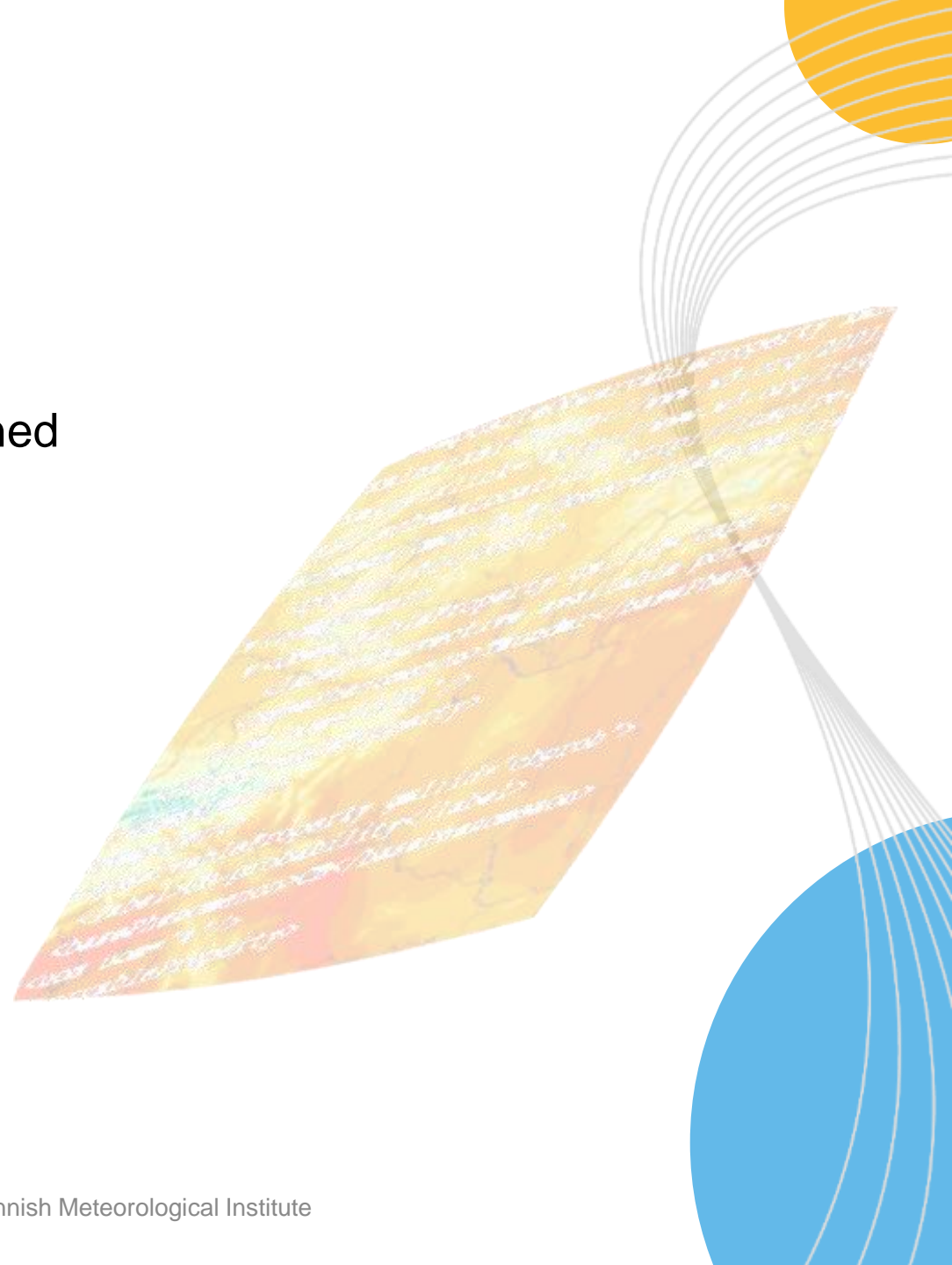



# Some Example Data Sets

Data set	Description	Time Interval	Estimated publish date
Weather Observations	Temperature, Wind, Humidity, Ground Temperature...	10 min	Open, older data to be added
Weather forecast model HIRLAM RCR	Point forecasts and grid data	Latest model run (4 times a day) 0...54 h	Open
Aviation Observations	METAR	30 min	open
Weather Radars	Precipitation Rate, Precipitation Amount...	5 min	Open, older data to be added
Lightning	Thunder Strikes in Finland	5 min	Open



# FMI Open Data Portal

FMI Open Data Portal follows INSPIRE requirements.

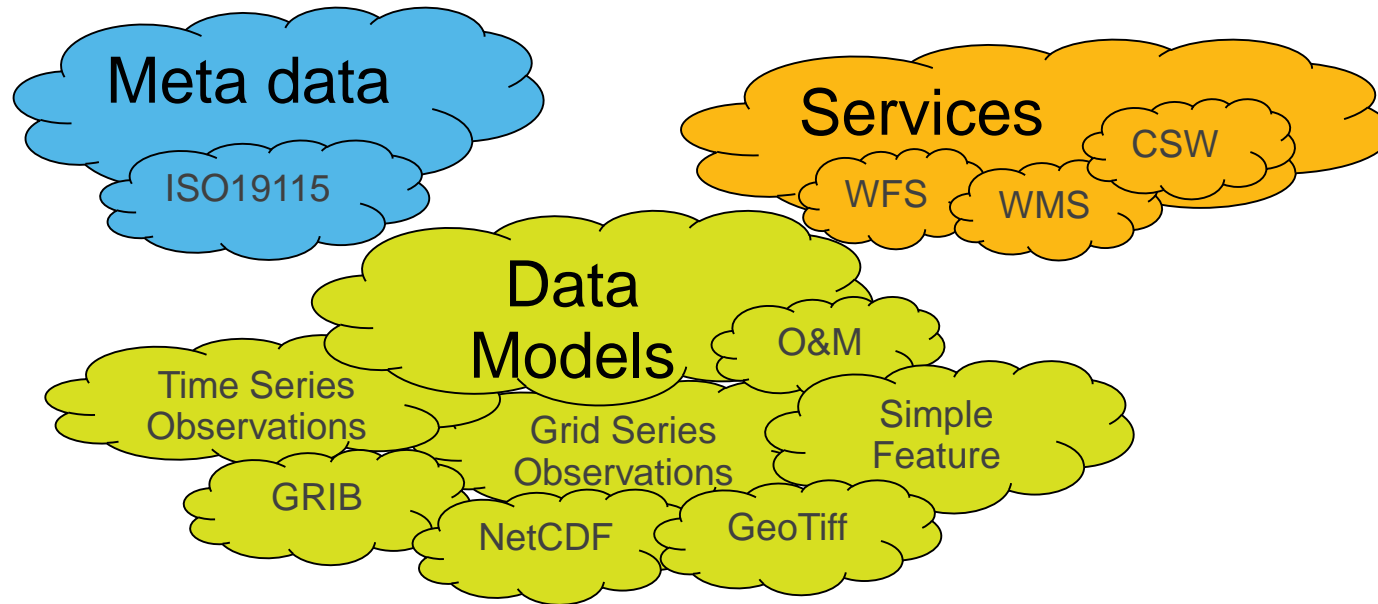

The very same data portal works as Open Data and INSPIRE portal.



# FMI Open Source Software

Finnish Meteorological  
Institute opened its data

2013

**FMI starts to open it's  
software**

2016



## FMI DATA

<https://en.ilmatieteenlaitos.fi/open-data>



# SmartMet Server

- Basis of FMI product generation

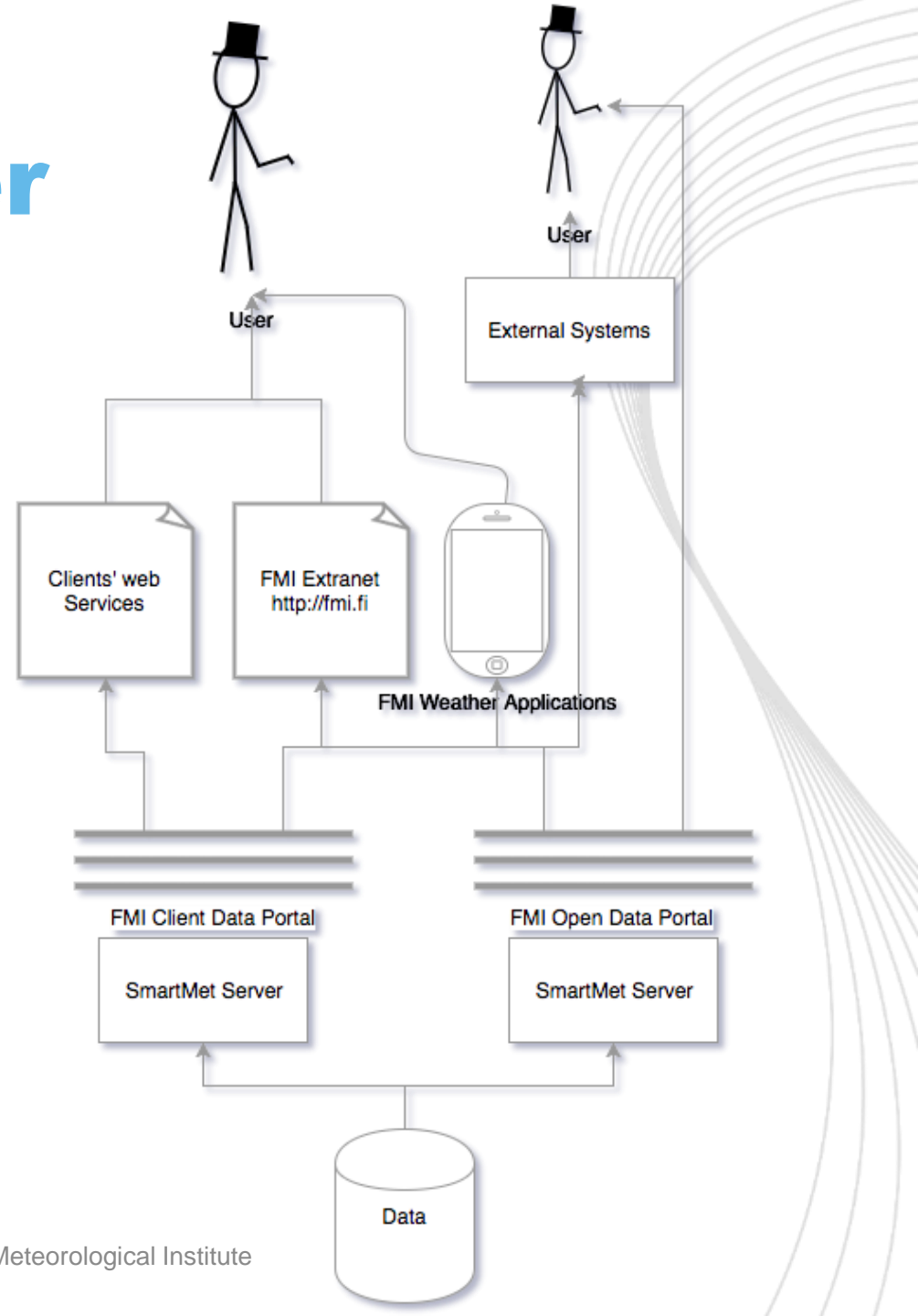
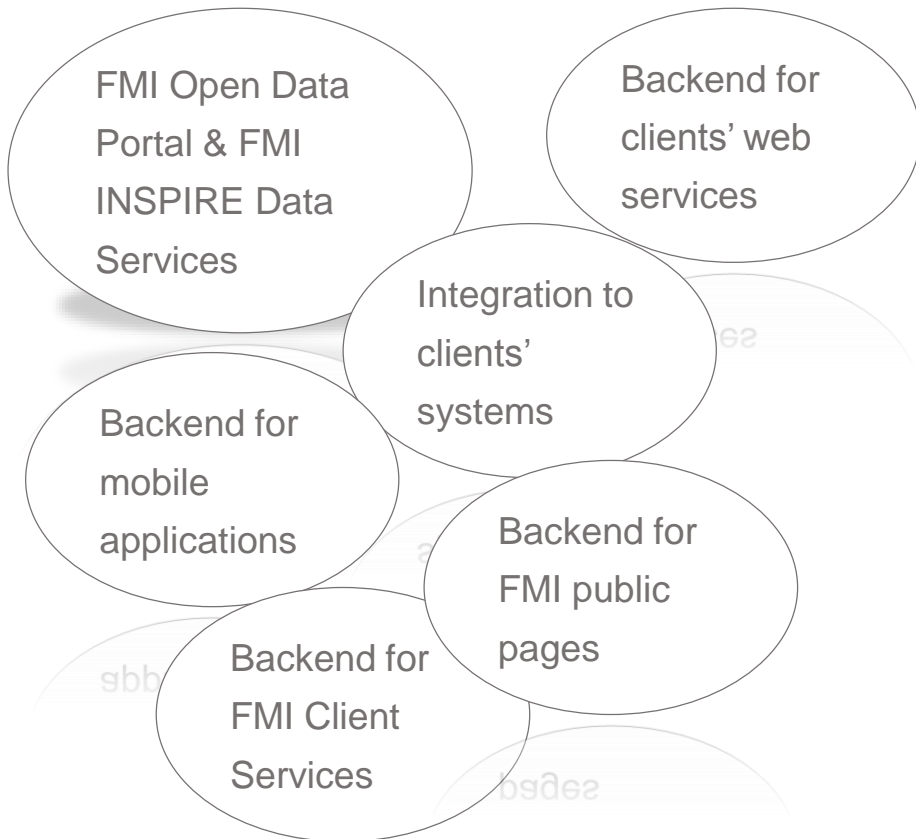



# In a Nutshell

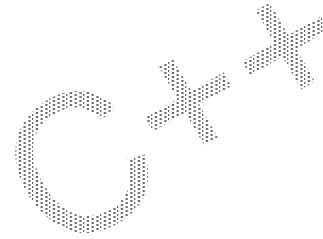

- Data and product server for MetOcean data
- High capacity & availability
  - FMI installation handles over 30 000 000 requests each day
- Data is extracted and products generated on-demand
- INSPIRE Compliant
- Operative since 2008
  - FMI client services (since 2008)
  - Finnish Meteorological Institute (FMI) Open Data Portal (since 2013)
  - Going to be used at Copernicus C3S Climate Data Store (ECMWF)
- Open source





# In a Nutshell

# C++

- Several input sources
  - GRIB-, NetCDF-, etc. files (multi-dimensional grid data)
  - PostGIS database (vectors)
  - Point database (point observations)
- Several output interfaces and formats
  - WMS, WFS 2.0
  - JSON, XML, ASCII, HTML, SERIAL
  - GRIB1, GRIB2, NetCDF





# Usage

- Basis of most FMI product generation

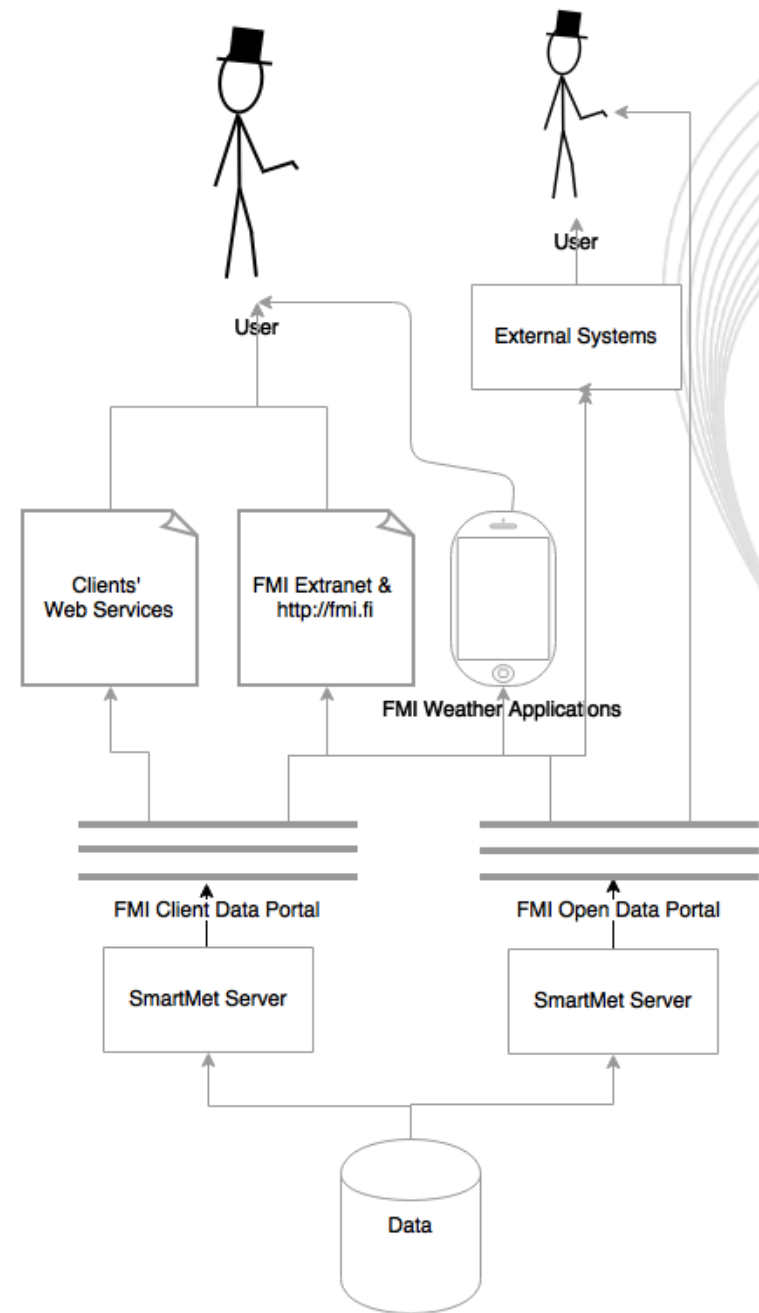
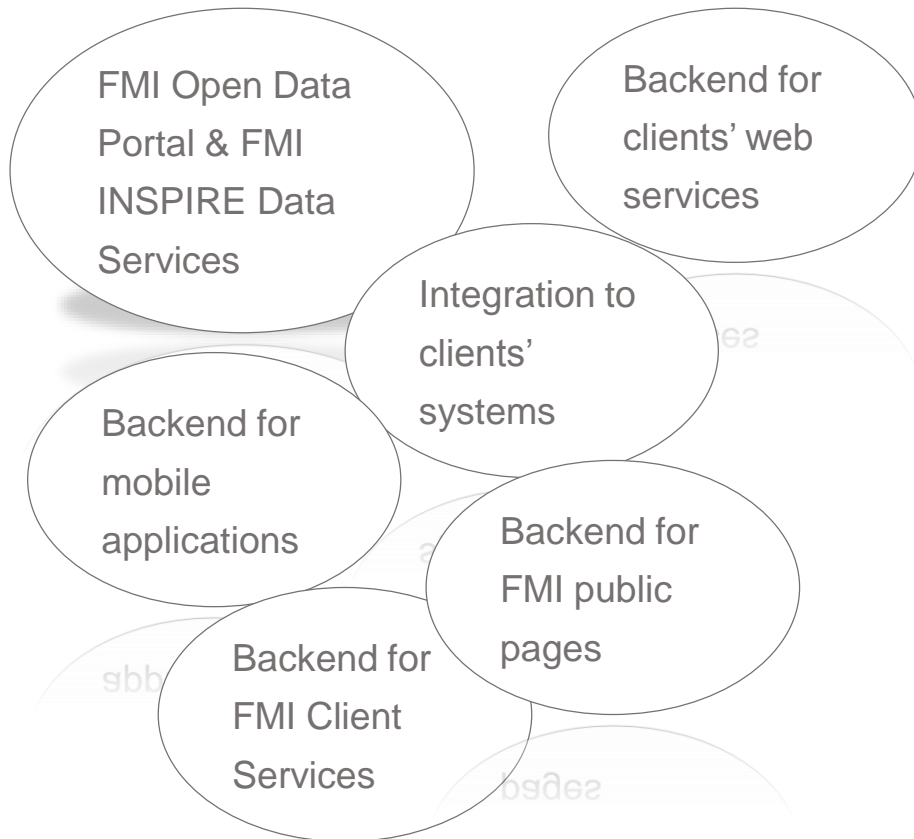



# Open Source

- Published in 2016 in GitHub
  - <https://github.com/fmidev/smartmet-server>
- MIT Licence
- Documentation in GitHub
  
- FMI will host the development
  - Small contributions with pull requests
  - In larger contributions, implementation plan is recommended (in GitHub wiki)
  - CLA (Contributor Licence Agreement) will be required





# Architecture

- Frontend
  - Load balancer
  - Knowledge about backend services
- Backend
  - Different backends may contain different services
- Plugin-based architecture
  - *Engines* provide shared access to the data
  - *Plugins* provide services (APIs) built upon engines

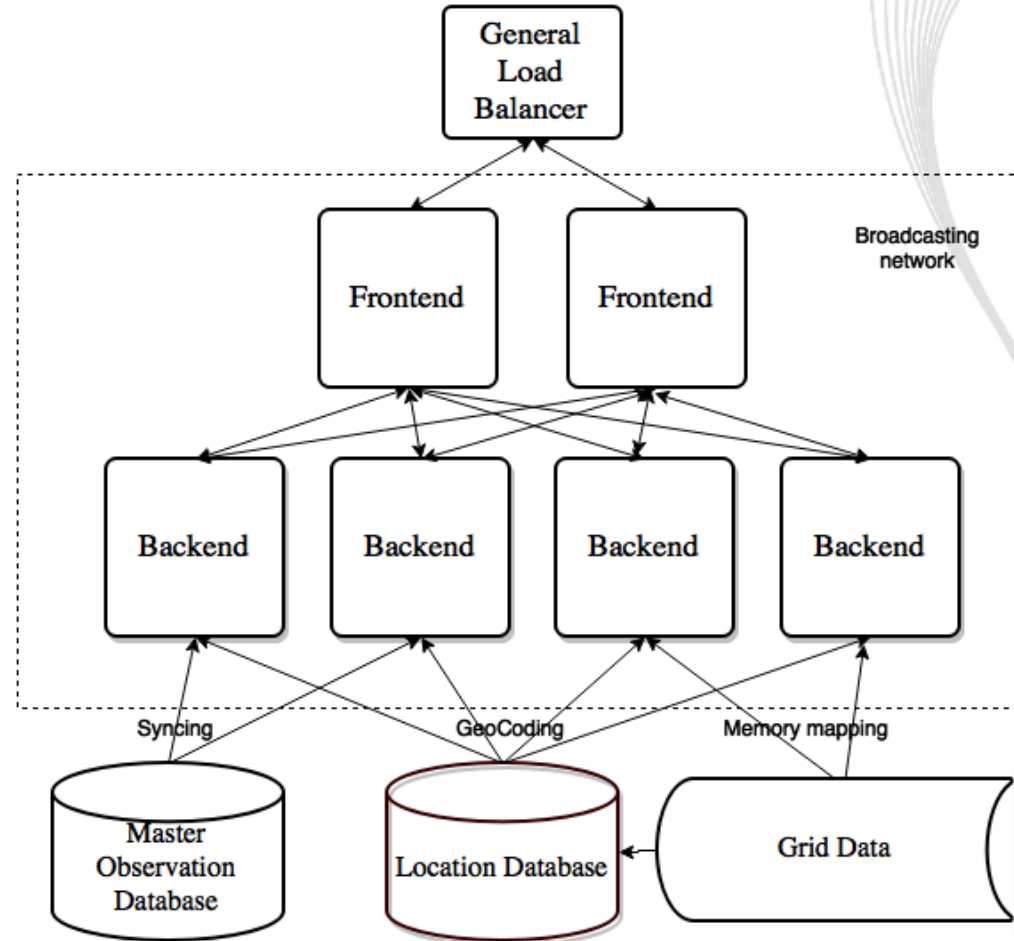



# Most Important Components

- Frontend
  - Provides HTTP 1.1 server
  - Monitors status of backend services and provides load balancing
  - Provides LRU product cache
- Data Engines (providing C++ API)
  - Querydata engine provides access to the grid data
  - Observation engine provide access to the point data in database
  - Geonames and gis engines provide geolocation information

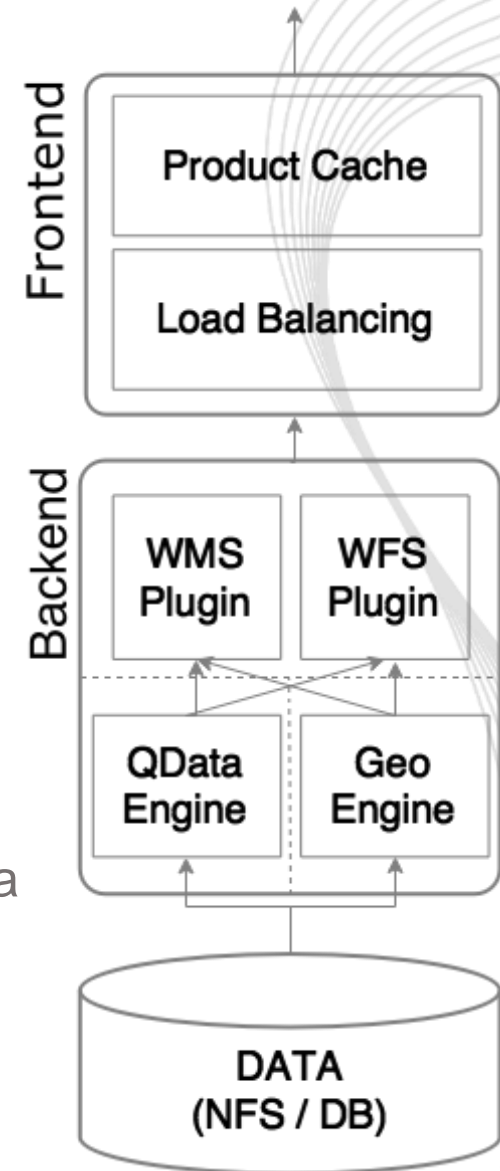



# Most Important Components

- Plugins (providing HTTP API)
  - **WMS**: Generates SVG images from grid data on-demand, which are rendered to requested raster format
  - **WFS**: Point data output for grid data and observations
  - **Timeseries**: Custom point data interface with support for aggregate values over time and area
  - **Download / WCS**: Grid data output

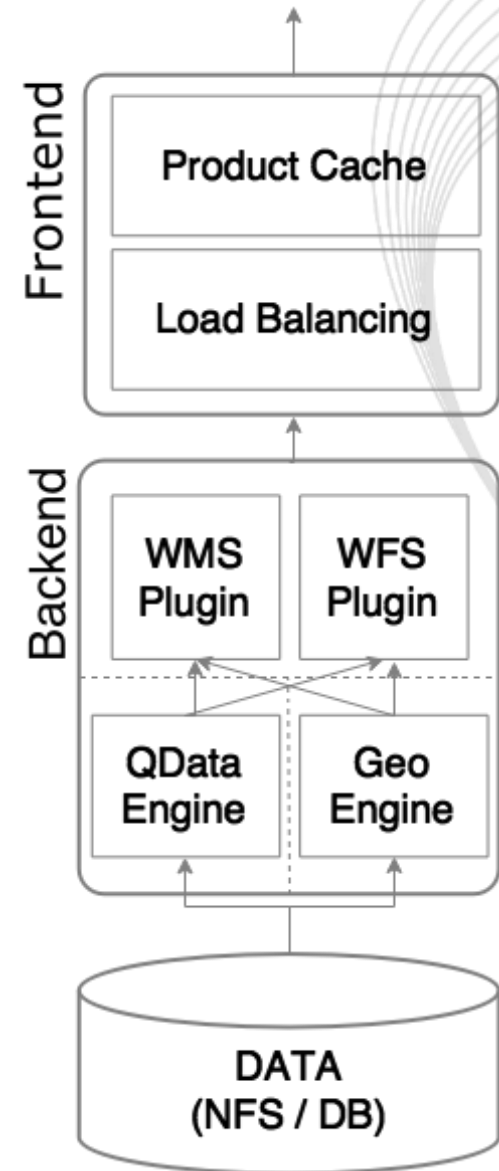



# Post-Processing Capabilities

- Corrects the data based on accurate DEM (up to 30 meter resolution) and land/water information
- Calculates derivative parameters
- Support for aggregate values over time and area

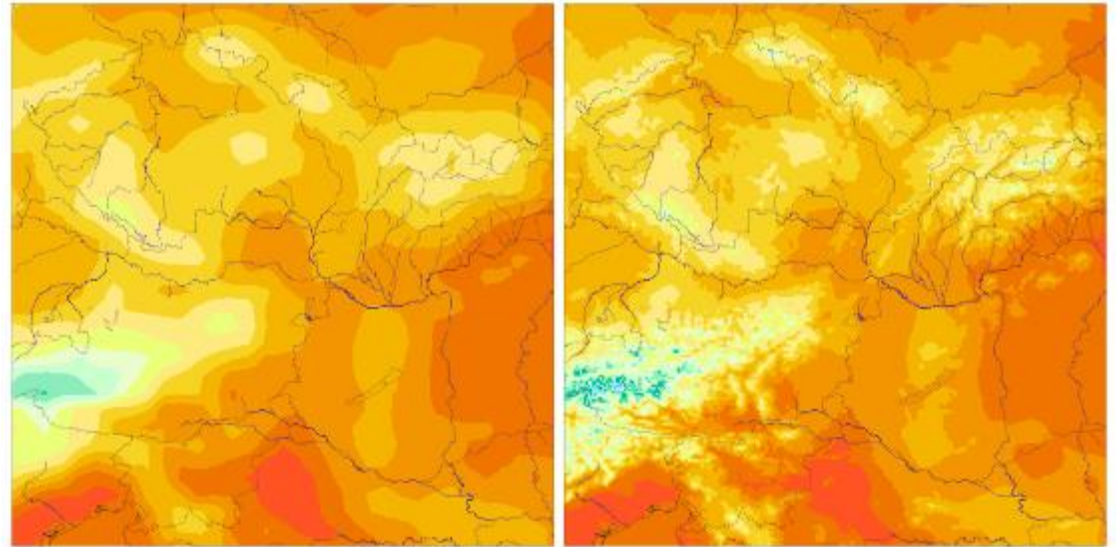



# FMI Setup In 2016

- 2 frontends
  - RAM: 256G
  - CPU: 24x 2.10GHz
  - OS: RHEL7
- 5 backends
  - RAM: 12G
  - CPU: 24x2.50GHz
  - OS: RHEL7
- Load Balancer
  - F5 BIG IP 11

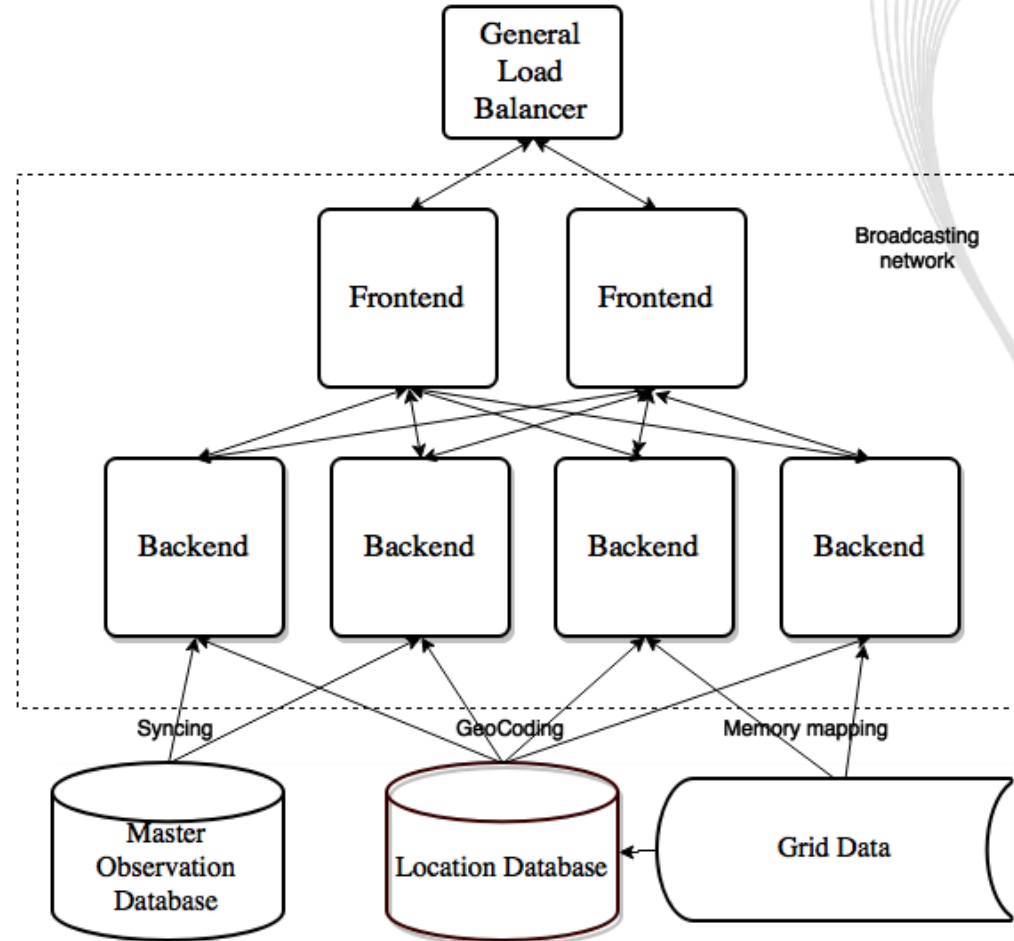





# Performance Production (FMI Setup)

## Typical load

- > 30 000 000 req/day
- Baseline 200 req/s
- Peaks over 650 req/s

## Average response times

WFS	140 ms/req
WMS	130 ms/req
Timeseries	30 ms/req
Autocomplete	4 ms/req

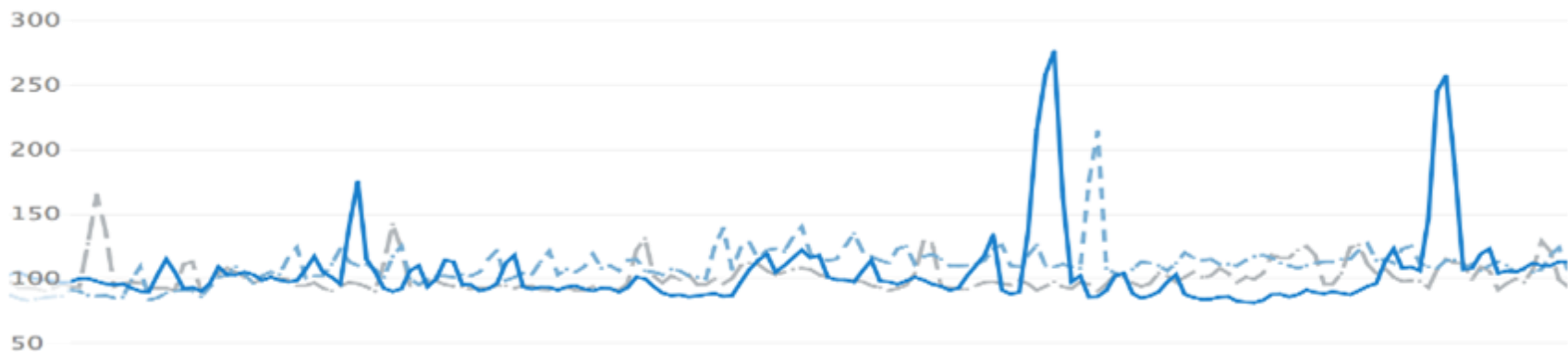



# Performance

## Load Tests (Production Setup)

- Scenario based on operative use at FMI
- Peaks over 4300 req/s
- Avg 173 ms, 95% of responses in 244 ms, median 54 ms
- Possibly heavy data requests require QoS management
  - Independent queues for slow and fast queries





# Roadmap

Native GRIB and NetCDF support for input data

Support for GRIB and NetCDF data as input data without converting data to internal data format

Clustering support over Internet

Possibility to provide data from it's original source via single API (*bring users to data*)

WCS support

Implement WCS interface for download plugin



# Hands-on?

Source code and documentation:

<https://github.com/fmidev/smartmet-server>

Unofficial Docker image:

<https://hub.docker.com/r/meteofi/smartmetserver/>

<https://github.com/fmidev>  
<https://en.ilmatieteenlaitos.fi/open-data>

<http://roopetervo.com>  
<http://www.slideshare.net/tervo>



FINNISH METEOROLOGICAL INSTITUTE

[www.fmi.fi](http://www.fmi.fi)